

Cat. No. 43-007
OWNER'S MANUAL

Please read before using this equipment.

ET-007

900 MHz Handsfree Cordless Headset System

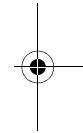
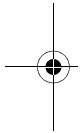

RadioShack®

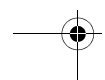
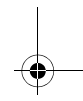
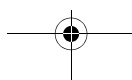
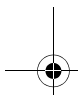

FEATURES

Your RadioShack ET-007 900 MHz Handsfree Cordless Headset System gives you communication with both portability and convenience. It includes a corded base telephone, a 900 MHz digital wireless headset, a wireless headset charger and an infrared remote dial card.

The Corded Base Telephone combines advanced telephone technology with 10 channels and 21 dialing memories. The Wireless Headset and Infrared Remote Dial Card give you great mobility during phone conversations.

Your ET-007 includes these features:

900 MHz — provides less interference and clearer sound than 46-49 MHz cordless phones.

Channel Auto Scan — automatically selects a clear channel when the headset is on the headset charger.

Security Interference Protection Code — prevents interference between different infrared remote dial cards.

1-Direct Dialing Memory — lets you store an important phone number so you can quickly dial the number by pressing a single button on the corded base phone.

20-Number Memory Dialing — lets you store 20 frequently called numbers (up to 20 digits) in memory for easy dialing.

Ample Talk and Standby Time — the supplied battery for the headset (when fully charged) provides about 7 hours of talk time and 5 days of standby time.

Dual Charging Slots — lets you charge a spare battery pack (not supplied) in the corded base telephone so that your phone is always ready to go, even with constant use.

Intercom — lets you page the wireless headset from the base or the base from the wireless headset, and hold a conversation with the person at the other end.

Base Ringer Switch — lets you adjust the phone's ringer volume to off, low or high.

Volume Control — lets you adjust the volume you hear through the handset, the infrared remote dial card, and the wireless headset.

Touch Tone or Pulse (Rotary) Dialing — lets you use your phone with either type of service.



Headset with Soft Foam-Filled Cushion — provides comfort when using the headset.

© 2000 Tandy Corporation.
All Rights Reserved.

RadioShack is a registered trademark used by Tandy Corporation.

Carry Strap — lets you hang the remote dial card from your neck for handsfree carrying.

WARNING: To reduce the risk of fire or shock hazard, do not expose this product to rain or moisture.

	CAUTION RISK OF ELECTRIC SHOCK. DO NOT OPEN.	
CAUTION: TO REDUCE THE RISK OF ELECTRIC SHOCK, DO NOT REMOVE COVER OR BACK. NO USER-SERVICEABLE PARTS INSIDE. REFER SERVICING TO QUALIFIED PERSONNEL.		



This symbol is intended to alert you to the presence of uninsulated dangerous voltage within the product's enclosure that might be of sufficient magnitude to constitute a risk of electric shock. Do not open the product's case.



This symbol is intended to inform you that important operating and maintenance instructions are included in the literature accompanying this product.

Your ET-007 is listed to UL standards and meets all applicable FCC standards.

READ THIS BEFORE INSTALLATION

We have designed your phone to conform to federal regulations and you can connect it to most phone lines. However, each device that you connect to the telephone line draws power from the line. We refer to this power draw as the phone's Ringer Equivalence Number (REN). The REN is shown on the bottom of your phone.

If you use more than one phone or other device on the line, add up all the RENs. If the total is more than five (three in rural areas), your phones might not ring. If ringer operation is impaired, remove one of the devices from the line.

FCC STATEMENT

Your telephone complies with Part 68 of *FCC Rules*. Upon request, you must provide the phone's FCC registration number and REN to your telephone company. These numbers are shown on the bottom of the phone.

Note: You must not connect your ET-007 to:

- coin-operated systems
- party-line systems
- most electronic key phone systems

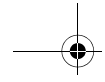

The ET-007 also complies with the limits for a Class B device as specified in Part 15 of FCC Rules. These limits provide reasonable protection against radio and TV interference in a residential area. However, your ET-007 might cause TV or radio interference even when it is operating properly. To eliminate interference, you can try one or more of the following corrective measures.

- Reorient or relocate the TV's receiving antenna.
- Increase the distance between the ET-007 and the radio or TV.
- Use outlets on different electrical circuits for the ET-007 and the radio or TV.

tions, if alternative signaling methods are not available.

- Work stations for hearing-impaired personnel.
- Hotel, motel, or apartment building lobbies.
- Stores where telephones are used to call taxis, reserve lodging, or rent automobiles.
- Some hotel and motel rooms. (At least ten percent of the rooms must contain hearing-aid compatible telephones, and hearing-aid compatible must be provided to hearing impaired customers upon request.)

The headset is not compatible with hearing aids. Therefore, the FCC prohibits its use in the following locations:

- Any public or semi-public location where coin-operated or credit card telephones are found.
- Elevators, highways, and tunnels (automobiles, subway, railroad, or pedestrian), where a person with impaired hearing might be isolated in an emergency.
- Places where telephones are installed specifically to alert emergency authorities such as fire, police, or medical assistance personnel.
- Hospital rooms, where telephones are used specifically for signaling life-threatening or emergency situa-

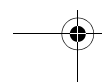
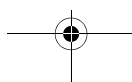

CONTENTS

Installation	6
Selecting a Location	6
Connecting the Handset	6
Placing the Base Telephone on a Desk	6
Connecting the Headset Charger, Wireless Headset and Infrared Remote Dial Card	7
Mounting the Corded Phone on a Wall or Wall Plate	8
Preparation	10
Charging the Battery Pack	10
Installing the Backup Battery Pack	10
Setting the Dialing Mode	11
Changing the Ringer Tone	11
Setting the Ringer Volume	12
Adjusting the Headset	12
Listening Safely	13
Operation	14
Making and Answering Calls	14
Using the Handset	14
Using the Wireless Headset	14
Switching Between the Handset and the Headset	14
Using Hold	14
Using the Intercom	15
Setting the Handset and Headset Volume	15
Using Redial	16
Using Flash	16
Using Hold	17
Using Tone Service on a Pulse Line	17
Memory Dialing	17
Storing a Number In Memory	17
Entering a Pause in a Memory Number	18
Dialing a Memory Number	18
Chain-Dialing	19
Testing Stored Emergency Numbers	19
Using the Intercom	19
From the Base	19
From the Headset	19
Troubleshooting	20
Care	22
The FCC Wants You to Know	22
Lightning	22

INSTALLATION

SELECTING A LOCATION

You can place the ET-007 on a desk or table, mount it on a standard wall plate, or mount it directly on a wall. Choose a location that is:

- near an AC outlet
- near a modular telephone line jack
- out of the way of normal activities

Note: Your ET-007 connects directly to a modular telephone line jack. If your phone line jack is not a modular jack, you can update the wiring yourself, using jacks and adapters available at your local RadioShack store. Or, you can let the phone company update the wiring for you.

Cautions:



You must use a Class 2 power source that supplies 9V DC and delivers at least 300 mA. Its center tip must be set to positive and its plug must fit the ET-007's **9V DC 300mA** jack. The supplied adapter meets these specifications. Using an adapter that does not meet these specifications could damage the ET-007 or the adapter.

- Always connect the AC adapter to the ET-007 before you connect it to AC power. When you finish, disconnect the adapter from AC power before you disconnect it from the ET-007.

CONNECTING THE HANDSET

Plug the supplied coiled handset cord into the jacks on the handset and the left side of the corded phone.

Note: Your local RadioShack store sells a variety of longer coiled handset cords, which are especially useful when you mount the phone on the wall.

PLACING THE BASE TELEPHONE ON A DESK

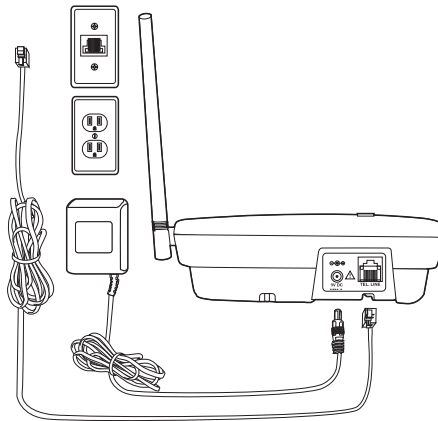

1. Plug one end of the supplied modular cord into the **TEL. LINE** jack on the back of the base.
2. Plug the modular cord's other end into a modular phone line jack.
3. Plug the supplied AC adapter's barrel plug into the **9V DC 300mA** on the back of the phone. Then plug the adapter into a standard AC outlet.

4. Route the adapter's cord through the strain relief slot on the bottom of the phone.
5. Lift the base telephone's antenna to a vertical position.

CONNECTING THE HEADSET CHARGER, WIRELESS HEADSET AND INFRARED REMOTE DIAL CARD

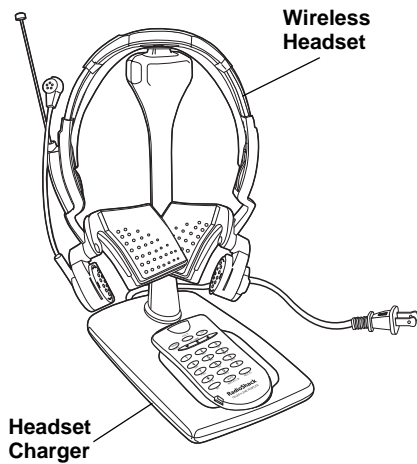

To connect the headset charger, connect the headset charger's built-in AC cord to the AC outlet. The plug fits only one way.

Follow these steps to connect the wireless headset:

1. Slide open the battery compartment cover on the left side of the headset.
2. Install the supplied rechargeable nickel-metal hydride (Ni-MH) battery

pack in the headset's battery compartment with the battery contact points down.

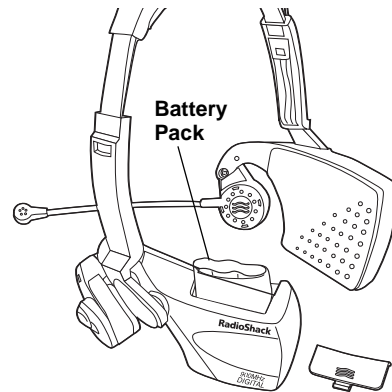

Important: You must install the battery pack and fully charge it before you can use the headset (see "Charging the Battery Pack" on Page 10).

3. Replace the cover.
4. Place the headset on the headset charger. The charging indicator on the headset lights red, then flashes slowly when the battery pack is fully charged.

Notes:

- The charging indicator lights when the headset is on the headset charger, even if there is no battery pack in the headset. Be sure the battery pack is inserted before charging.

- The INTERCOM and HOLD indicators on the corded phone stop flashing after the headset charger and wireless headset are connected, even when there is no battery pack in the headset. If they flash, move the headset and charger closer to the corded phone.

Remove the battery insulation strip from the infrared remote dial card's battery compartment. Then place the dial card in its cradle on the headset charger.

If you cannot operate the headset using the remote dial card, you might need to replace the dial card's battery. Slide off the battery compartment cover and use a pointed object (such as a straightened paper clip) to gently pry out the old battery. Insert a fresh CR2025 lithium button-cell battery (available from your local RadioShack store), then replace the cover.

Note: To detach the supplied carry strap, gently pull on the carry strap's small loop, then pull the strap through the small loop. To reattach the strap, slide the small loop into the carry strap slot on the remote dial card. Then insert the strap through the small loop and pull to tighten.

MOUNTING THE CORDED PHONE ON A WALL OR WALL PLATE

You can use the supplied mounting bracket to mount the corded base phone on a wall.

Notes:

- When mounting the base telephone on a wall plate, use the supplied modular cord to connect the phone to the wall plate jack.
- To mount the base telephone directly on a wall, use two $\frac{3}{16}$ -inch (5mm) screws (not supplied). Drill two holes $3\frac{15}{16}$ inches (100 mm) apart. Then thread a screw into each hole, letting the heads extend about $\frac{1}{8}$ inch (3 mm) from the wall.

1. To connect the bracket, insert the tabs on the bracket into the slots in the lower position on the base. Then press the upper side of the bracket to the base until it snaps into place.

To remove the bracket, press in the upper tab on each side of the bracket and lift the bracket away from the base.

2. Plug one end of the supplied modular cord into the phone's **TEL.LINE** jack and the AC adapter's barrel plug into the DC jack.

3. Route the modular cord into the right groove on the mounting bracket and route the AC adapter's cord into the left groove.

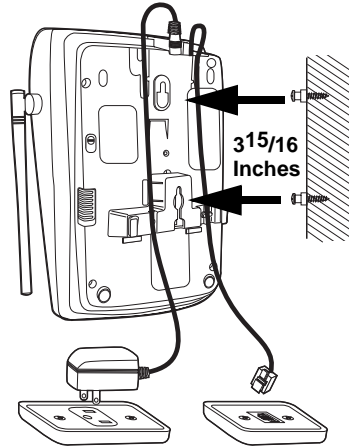

6. Plug the other end of the modular cord into the phone line jack and the AC adapter into a standard AC outlet.
7. Lift the antenna to a vertical position.

4. Press up on the handset holder to remove it, turn it over, then slide it back down into its slot.

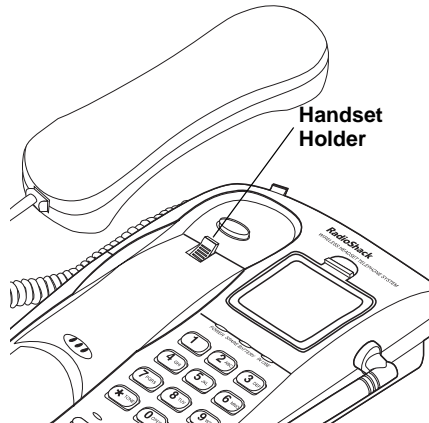

5. Place the phone's two keyhole slots over the wall plate studs (or the screws, if you are mounting the phone on a wall). Press downward on the phone to secure it.

PREPARATION

Follow the steps in “Connecting the Headset Charger, Wireless Headset and Infrared Remote Dial Card” on Page 7 to install the battery in the headset.

CHARGING THE BATTERY PACK

After you install a battery pack, let the battery charge for about 24 hours before you use the headset the first time. The charging indicator on the headset lights red.

The headset charges whenever it is on the headset charger. You can charge the battery at any time, but you must charge the battery when the IN USE/ BATT. LOW indicator lights red (or flashes yellow when using the headset).

Note: If the charging indicator does not light when you place the headset on the headset charger, be sure the battery is installed correctly inside the battery compartment and the plug is securely connected on the headset charger. Also, be sure the headset is placed properly on the headset charger.

INSTALLING THE BACKUP BATTERY PACK

Your phone requires a 3.6V rechargeable Ni-MH battery pack (not supplied) for backup power when AC power fails. In case of a power failure, you can make and receive calls for up to four hours with a fully charged battery pack.

Follow these steps to install a battery pack in the base.

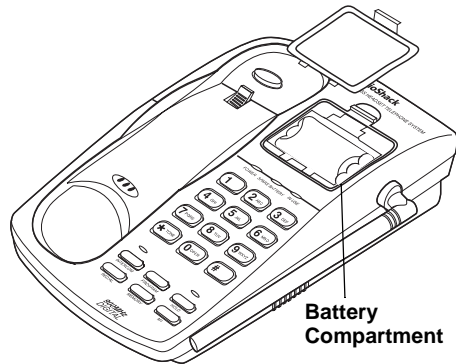

1. Push down the tab of the battery compartment cover (located above the keypad on the corded phone's base) and lift off the cover.
2. Place the battery pack in the battery compartment with the battery's connectors in contact with the battery compartment's connectors.
3. Replace the cover.

When you install a battery in the base, the SPARE BATTERY indicator lights and the battery pack automatically begins charging. The battery pack takes about 24 hours to fully charge.

SETTING THE DIALING MODE

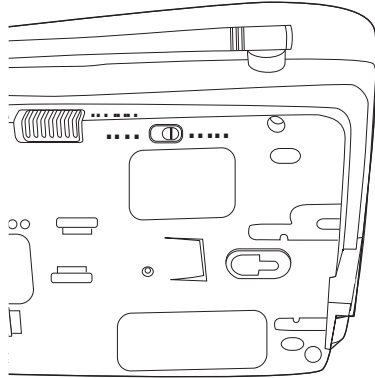

Set **TONE/PULSE** on the bottom of the corded phone for the type of service you have, either tone or pulse (rotary). If you are not sure which type you have, do this simple test.

1. Set **TONE/PULSE** to **TONE**.
2. Lift the handset and listen for a dial tone.
3. Press any number except 0 and 1.

Note: If your phone system requires that you dial an access code (9, for example) before you dial an outside number, do not press the access code either.

If the dial tone stops, you have touch-tone service. If the dial tone continues, you have pulse service.

4. If you have pulse service, set **TONE/PULSE** to **PULSE**.

CHANGING THE RINGER TONE

There are four different ringer tones you can choose or you can turn off the ringer. The ringer system is separate for the corded phone and wireless headset. Follow these steps to change the ringer tone:

1. Make sure the phone is on-hook. Press **PROGRAM** on the base.

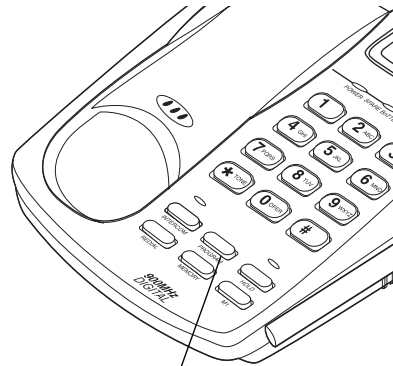

PROGRAM

2. Press **#**, then **1** for the base ringer tone, or **2** for the headset ringer tone.
3. Press **1**, **2**, **3** or **4**. You hear the corresponding ringer tone. To turn off the headset's ringer, press **0**.
4. Press **PROGRAM** to select the desired ringer tone. A confirmation ring sounds, indicating that you successfully set the desired ringer tone.

SETTING THE RINGER VOLUME

To adjust the ringer volume on the corded base phone, slide the switch on the right side of the base to **RINGER OFF**, **LOW** or **HI**.

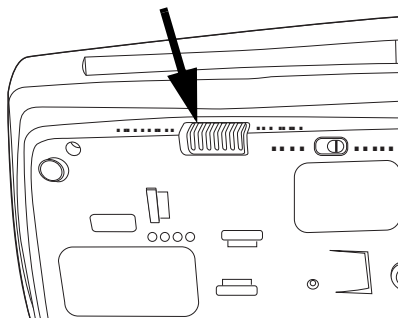

If you do not want the ringer to sound, slide the switch to **OFF**. You can make calls with the ringer off, and you can answer calls if you hear another phone on the same phone line ring.

Note: To temporarily turn off the headset's ringer while the phone rings, press **VOL ▲** or **▼** on the side of the headset, or **VOLUME ▲** or **▼** on the remote dial card. The headset's ringer turns back on when you hang up the phone.

ADJUSTING THE HEADSET

1. Press **VOL ▼** to set the volume to the lowest level, then place the headset on your head with the microphone in the front.

2. If necessary, adjust the headset band on both sides by pulling down or pushing up on each end until it fits with almost no pressure on your ears or the top of your head.

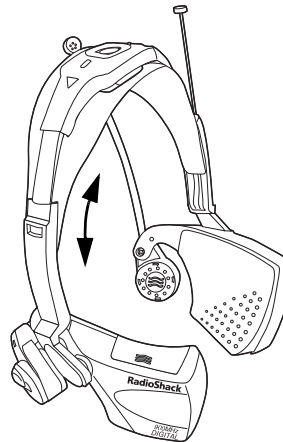

3. Pull down the microphone, adjusting it to about even with your chin. Experiment until you find the most comfortable position.

Caution: The microphone swivels on the headset. Do not bend the microphone while you adjust it.

Note: If you hear a dial tone when you pull down the microphone, press **OFF** on the infrared remote dial card.

When you are not using the headset, place it on the headset charger. Otherwise, you might need to repeat these adjustments.

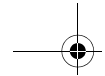

Listening Safely

To protect your hearing, follow these guidelines when you use the headset.

- Set the volume to the lowest setting before you begin listening. After you begin listening, adjust the volume to a comfortable level.
- Do not listen at extremely high volume levels. Extended high volume listening can lead to permanent hearing loss.
- Once you set the volume, do not increase it. Over time, your ears adapt to the volume level, so a volume level that does not cause discomfort might still damage your hearing.

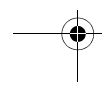
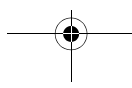
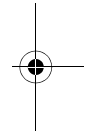
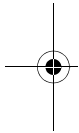

OPERATION

MAKING AND ANSWERING CALLS

Using the Handset

To make a call, pick up the handset and dial normally. The IN USE indicator flashes when you receive a call and lights while the phone is in use.

Pick up the handset to answer a call and place the handset on the base to end a call.

Note: The corded phone will not operate without AC power. During a power failure, use a backup battery for the base corded phone, or another phone on the same line.

Using the Wireless Headset

1. Place the wireless headset on your head and adjust the headband and microphone for a comfortable fit.
2. Pull down the microphone until it clicks and you hear a dial tone. Dial the desired number using the infrared remote dial card.
3. To answer an incoming call, pull down the microphone until it clicks and wait about 1 second.

Notes:

- If the headset is on the headset charger and the microphone is pulled down, place the headset on your head, then press **PHONE/FLASH** on the infrared remote dial card to answer a call.

- The headset only receives a signal from the remote dial card if the microphone is pulled down. The dial card does not work if the microphone is pulled up.

4. When you finish a call, pull the microphone up until it clicks, or press **OFF** on the infrared remote dial card, or put the headset back on the headset charger.

Notes:

- The infrared remote dial card only controls the headset, not the corded phone.
- If the headset does not work, move the dial card closer to the sensor on the left side of the headset. If it still does not work, replace the battery in the dial card.

SWITCHING BETWEEN THE HANDSET AND THE HEADSET

Using Hold

To switch from the handset to the headset, press **HOLD** on the corded phone, then place the handset on the cradle. The IN USE/BATT. LOW indicator on the headset and the HOLD indicator on the base flash. Put on the headset and pull down the microphone. The HOLD indicator on the base turns off, while the IN USE/BATT. LOW indicator on the headset lights and the IN USE indicator on the base flashes.

To switch from the headset to the handset, press **HOLD** on the infrared remote dial card. The IN USE/BATT. LOW indicator flashes. Pick up the handset to answer the call. The headset sounds a tone if the handset is not picked up within about 30 seconds.

Using the Intercom

To use the intercom to switch from the handset to the headset, press **HOLD** then **INTERCOM** on the base. The headset rings. Press **INTERCOM** on the remote dial card. You can talk to the person on the handset. To transfer the call to the headset, press **PHONE/FLASH**, then place the handset on the cradle.

To use the intercom to switch from the headset to the handset, press **HOLD** then **INTERCOM** on the remote dial card. When the corded phone rings, pick up the handset. You can talk to the person on the headset. To transfer the call to the handset, press **INTERCOM** then **HOLD** on the base.

Notes:

- If you are using the handset and you press **INTERCOM** during a call, the call cannot be transferred to the headset. The call is disconnected, the headset rings, and you can use the intercom.
- If you are using the headset during a call, press **INTERCOM** on the remote dial card to mute the microphone. To resume the call, press **INTERCOM** on the remote dial card or pick up

the handset to continue the call. To end the call, press **OFF** on the remote dial card, pull the microphone up until it clicks, or put the headset on the charger.

SETTING THE HANDSET AND HEADSET VOLUME

To control the handset volume, slide the switch on the side of the handset (**Low, Med, Hi**) to adjust to a comfortable listening level.

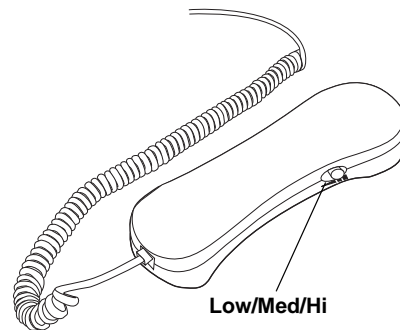

To select one of the headset's 8 volume listening levels while using the headset, press the **VOL ▲** or **▼** on the side of the headset, or press **VOLUME ▲** or **▼** on the infrared remote dial card.

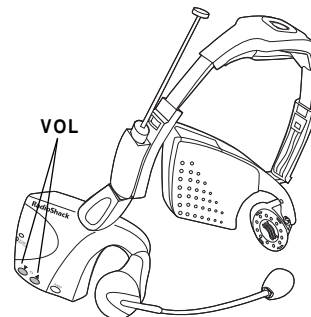

USING REDIAL

You can quickly dial the last number dialed. When you heard a dial tone, press **REDIAL** on the corded phone, or on the infrared remote dial card if you want to use the headset for dialing.

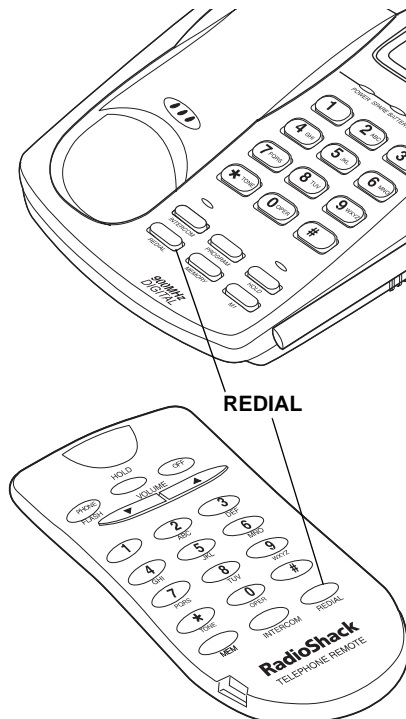

Note: The base corded phone and the headset record their own last number dialed. You cannot redial the last number recorded in the corded base phone by using the headset.

USING FLASH

Flash performs the switchhook operation for special services, such as Call Waiting.

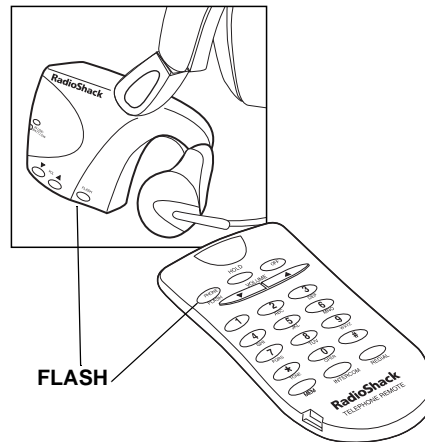

For example, if you have Call Waiting, press **FLASH** on the headset, **PHONE/FLASH** on the remote dial card or the switchhook on the base to take an incoming call without disconnecting the current call. Press **FLASH**, **PHONE/FLASH** or the switchhook again to return to the first call.

Note: If you do not have special phone services, pressing **FLASH** (**PHONE/FLASH** on the remote dial card or the switchhook on the base) might disconnect the current call.

USING HOLD

To put a caller on hold, press **HOLD**. The **HOLD** indicator on the corded phone flashes and you can hang up the handset without disconnecting the call. Or, if you are using the headset, press **HOLD** on the infrared remote dial card.

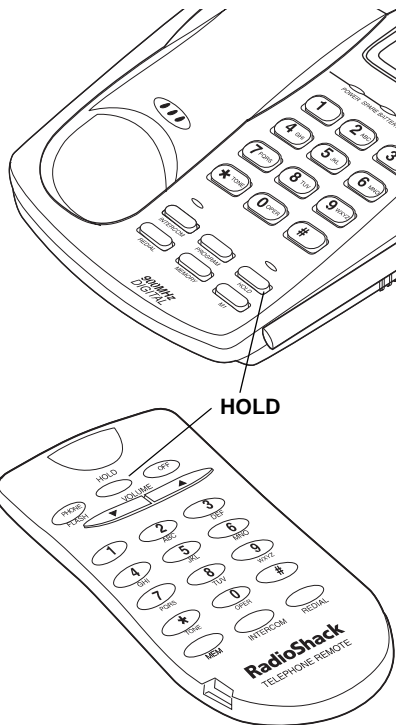

To resume the call, lift the handset, pull down on the microphone until it clicks, or pick up any extension phone on the same line.

Note: If another extension is in use on the same line, the **IN USE** indicator on the corded phone flashes red and the **IN USE/BATT. LOW** indicator on the headset flashes green.

USING TONE SERVICE ON A PULSE LINE

If you have pulse service, you can still use special services that require tone signals, such as bank-by-phone, by following these steps.

1. Be sure **TONE/PULSE** is set to **PULSE**.
2. Dial the service's main number.
3. When the service answers, press *****. Any additional numbers you dial are sent as tone signals.
4. When you hang up, the phone automatically resets to pulse mode.

MEMORY DIALING

Your ET-007 has one direct memory (00) location and twenty indirect memory locations (01–20) for storing frequently used phone numbers. Each number can contain up to 20 digits.

Note: Memory storing can only be programmed using the corded phone.

Storing a Number In Memory

1. Be sure the phone is not in use, then press **PROGRAM**.
2. Enter the 2-digit memory location (**00** for the direct memory, or **01** to **20** for indirect memory). The phone rings.

3. Enter the number you want to store (up to 20 digits can be stored), including any pause or tone entries (see "Entering a Pause in a Memory Number" on Page 18 or "Using Tone Service on a Pulse Line" on Page 17).
4. Press **MEMORY** on the base. The phone rings to indicate that the number is stored successfully.

Notes:

- If you make a mistake while entering the number, press **PROGRAM** to exit. A beep sounds. Start again at Step 1.
- You cannot store a memory number if the headset is not connected.

Entering a Pause in a Memory Number

In some telephone systems, you must dial an access code (9, for example) and wait for a second dial tone before you can dial an outside number. To enter a 2-second pause (for an access code, for example), press **HOLD** at the appropriate point when you store a number.

Note: Each pause entry uses one digit of memory.

Dialing a Memory Number

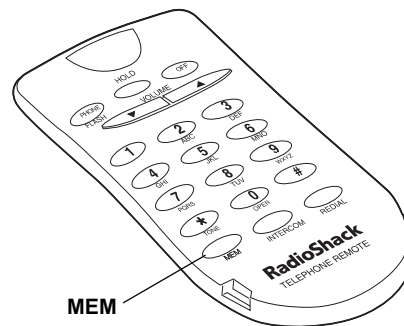
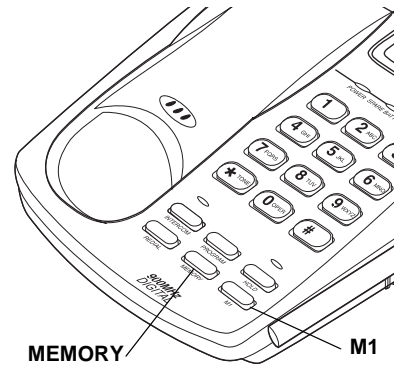

To dial a number stored in direct memory, press **M1** on the base, or **MEM** then **00** on the infrared remote dial card for headset use.

To dial a number stored in memory, press **MEMORY** (or **MEM** on the remote dial card), then enter the desired memory location number (**01–20**).

Chain-Dialing

For quick recall of numbers for special services (such as bank-by-phone or alternate long-distance), you can store each group of numbers in its own memory location. Then, when calling special services, dial the service's main number first. At the appropriate place in the call, press the memory location button for the additional numbers you want to send.

Testing Stored Emergency Numbers

If you store an emergency service's number (police department, fire department, ambulance) and you want to test the stored number, make the test call during the late evening or early morning hours to avoid peak demand periods. Remain on the line to explain the reason for your call.

USING THE INTERCOM

The intercom feature lets you send a page from the base handset to the headset, so that you can talk to someone at the headset or locate it if you misplaced it.

From the Base

1. Press **INTERCOM** on the base. The headset sounds five series of continuous beeps until someone picks up the phone.

2. Put on the headset, pull down the microphone, and press **OFF** then **INTERCOM** on the remote dial card. The corded base phone rings and the INTERCOM indicator on the base flashes.

Note: You must pull down the microphone on the headset to use the remote dial card.

3. To answer the call, pick up the handset or press **INTERCOM** on the dial card again. Otherwise, the corded base phone rings five times, then stops.

If the handset is off the hook, press **INTERCOM** on base. The headset rings. Press **INTERCOM** on the remote dial card to talk. Or, press **INTERCOM** on the base to stop the ringing.

From the Headset

Press **INTERCOM** on the infrared remote dial card. The corded base phone rings. Pick up the handset to answer the call. The INTERCOM indicator on the base lights.

Or, press **INTERCOM** on the remote dial card to stop the ringing. Otherwise, the corded phone rings five times and then stops.

TROUBLESHOOTING

We do not expect you to have any problems with your phone, but if you do, the following suggestions might help. If you still have problems, take the phone to your local RadioShack store for assistance.

Problem	Suggestion
Interference is severe.	Move the wireless headset closer to the base.
	Keep the wireless headset away from interfering sources such as computers, radio-controlled toys, wireless microphones, wireless alarm systems, wireless intercoms and room monitors, fluorescent lights, and electrical appliances.
	Turn off the interfering device.
	Hang up and redial the number.
The range decreases.	Raise the base's antenna to a vertical position.
	Make sure the antenna on the base and headset are not touching any metal surface.
	Recharge the headset battery pack.
The corded base phone does not work.	Make sure the phone's modular cord and the AC adapter are correctly and securely connected.
	Move the wireless headset closer to the base.
	Raise the base's antenna to a vertical position.
	Recharge the headset's battery pack. If the battery power is too low, the IN USE/BATT. LOW indicator does not light. See "Charging the Battery Pack" on Page 10.

Problem	Suggestion
The base's INTERCOM and HOLD indicators flash.	Move the wireless headset closer to the base.
	Make sure the headset charger is connected to DC power and the wireless headset is seated securely on the charger.
No dial tone.	Check to make sure the modular telephone and handset cords are securely connected.
Low volume or unusual sounds.	Someone has picked up another phone on the same line. Hang up the other phone.
Trouble transmitting while using the headset. (The caller has trouble hearing you, but you can hear the caller.)	Make sure the microphone boom is not too far away from your mouth.
	Check the headset battery power.
Trouble receiving while using the headset or the headset does not work.	Check the headset battery power.
	Make sure the phone lines are operating correctly.
	Check to see if other phones on the same line are working.

If you still have problems, disconnect the phone. If other phones on the same line work properly, the fault is in this phone or its installation. If you cannot find the problem, take the phone to your local RadioShack store for assistance.

CARE

To enjoy your RadioShack ET-007 900 MHz Handsfree Cordless Headset System for a long time:

- Keep the ET-007 dry. If it gets wet, wipe it dry immediately.
- Use and store the ET-007 only in normal temperature environments.
- Handle the ET-007 gently and carefully. Do not drop it.
- Keep the ET-007 away from dust and dirt.
- Wipe the ET-007 with a damp cloth occasionally to keep it looking new.

Modifying or tampering with the ET-007's internal components can cause a malfunction and invalidate its warranty. If your ET-007 is not performing as it should, take it to your local RadioShack store for assistance. If the trouble is affecting the telephone lines, the phone company can ask you to disconnect your ET-007 until you have resolved the problem.

THE FCC WANTS YOU TO KNOW

In the unlikely event that your phone causes problems on the phone line, the phone company can temporarily discontinue your service. If this happens, the phone company attempts to notify you in advance. If advance notice is not practical, the phone company notifies you as soon as possible and advises you of your right to file a complaint with the FCC.

Also, the phone company can make changes to its lines, equipment, operations, or procedures that could affect the operation of this telephone. The telephone company notifies you of these changes in advance, so you can take the necessary steps to prevent interruption of your telephone service.

LIGHTNING

Your telephone has built-in protection circuits to reduce the risk of damage from surges in telephone line current. These protection circuits meet or exceed the FCC requirements. However, lightning striking the telephone lines can damage your telephone.

Lightning damage is not common. Nevertheless, if you live in an area that has severe electrical storms, we suggest that you unplug your telephone during storms to reduce the possibility of damage.

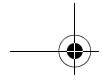

NOTES

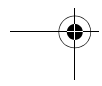
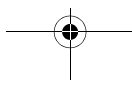
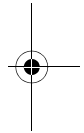
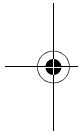

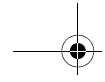

Limited One-Year Warranty

This product is warranted by RadioShack against manufacturing defects in material and workmanship under normal use for one (1) year from the date of purchase from RadioShack company-owned stores and authorized RadioShack franchisees and dealers. EXCEPT AS PROVIDED HEREIN, RadioShack MAKES NO EXPRESS WARRANTIES AND ANY IMPLIED WARRANTIES, INCLUDING THOSE OF MERCHANTABILITY AND FITNESS FOR A PARTICULAR PURPOSE, ARE LIMITED IN DURATION TO THE DURATION OF THE WRITTEN LIMITED WARRANTIES CONTAINED HEREIN. EXCEPT AS PROVIDED HEREIN, RadioShack SHALL HAVE NO LIABILITY OR RESPONSIBILITY TO CUSTOMER OR ANY OTHER PERSON OR ENTITY WITH RESPECT TO ANY LIABILITY, LOSS OR DAMAGE CAUSED DIRECTLY OR INDIRECTLY BY USE OR PERFORMANCE OF THE PRODUCT OR ARISING OUT OF ANY BREACH OF THIS WARRANTY, INCLUDING, BUT NOT LIMITED TO, ANY DAMAGES RESULTING FROM INCONVENIENCE, LOSS OF TIME, DATA, PROPERTY, REVENUE, OR PROFIT OR ANY INDIRECT, SPECIAL, INCIDENTAL, OR CONSEQUENTIAL DAMAGES, EVEN IF RadioShack HAS BEEN ADVISED OF THE POSSIBILITY OF SUCH DAMAGES.

Some states do not allow limitations on how long an implied warranty lasts or the exclusion or limitation of incidental or consequential damages, so the above limitations or exclusions may not apply to you.

In the event of a product defect during the warranty period, take the product and the RadioShack sales receipt as proof of purchase date to any RadioShack store. RadioShack will, at its option, unless otherwise provided by law: (a) correct the defect by product repair without charge for parts and labor; (b) replace the product with one of the same or similar design; or (c) refund the purchase price. All replaced parts and products, and products on which a refund is made, become the property of RadioShack. New or reconditioned parts and products may be used in the performance of warranty service. Repaired or replaced parts and products are warranted for the remainder of the original warranty period. You will be charged for repair or replacement of the product made after the expiration of the warranty period.

This warranty does not cover: (a) damage or failure caused by or attributable to acts of God, abuse, accident, misuse, improper or abnormal usage, failure to follow instructions, improper installation or maintenance, alteration, lightning or other incidence of excess voltage or current; (b) any repairs other than those provided by a RadioShack Authorized Service Facility; (c) consumables such as fuses or batteries; (d) cosmetic damage; (e) transportation, shipping or insurance costs; or (f) costs of product removal, installation, set-up service adjustment or reinstallation.

This warranty gives you specific legal rights, and you may also have other rights which vary from state to state.

RadioShack Customer Relations, 200 Taylor Street, 6th Floor, Fort Worth, TX 76102

We Service What We Sell

12/99

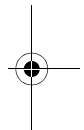
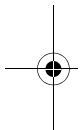

RadioShack
A Division of Tandy Corporation
Fort Worth, Texas 76102

03A00

Printed in China

